

Curve



Make a Scene

Curve by Spotlight Solar brings clean energy to center stage. It reminds people of the good things you do to protect the environment and save energy, and makes solar technology more visible.

Curve is both art and a clean energy machine. Its design is approachable and fresh. Curve's solar array orients in any direction you decide – to balance shading and energy production. It even comes in your favorite color, and offers accessories like accent lighting, a table with power outlets, seating and branding.

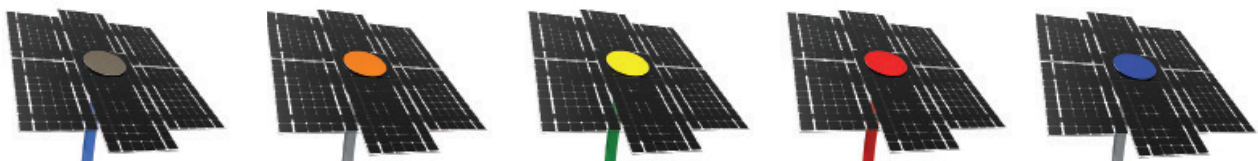

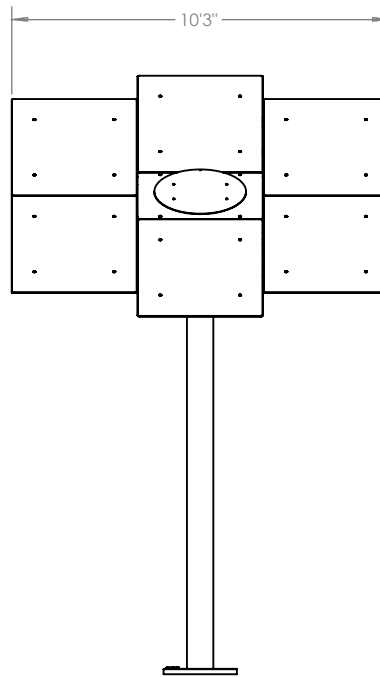
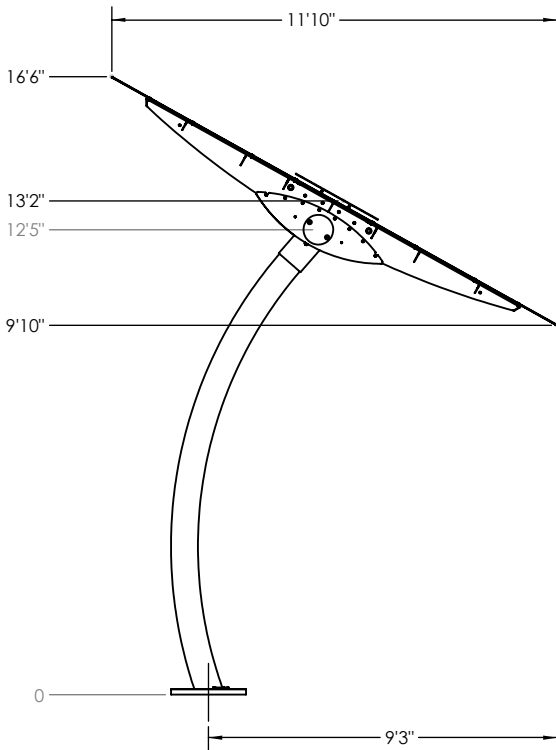
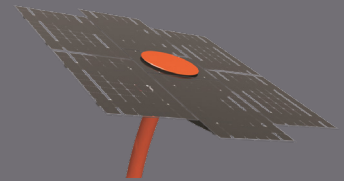

Array shown at 25 degree angle, no Twist. Dimensions will vary with site-specific Tilt and Twist orientation.

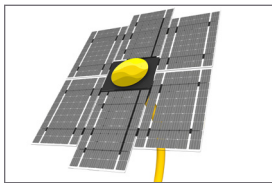

Optional top disk logo plate

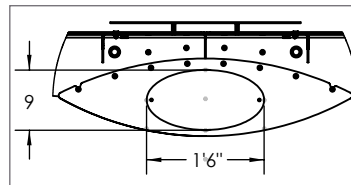

Optional joint logo plate

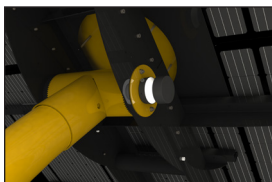

Optional accent light



Optional seat

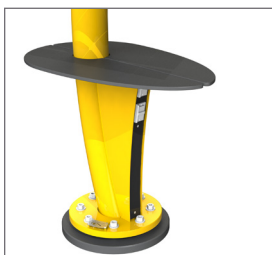

Optional table

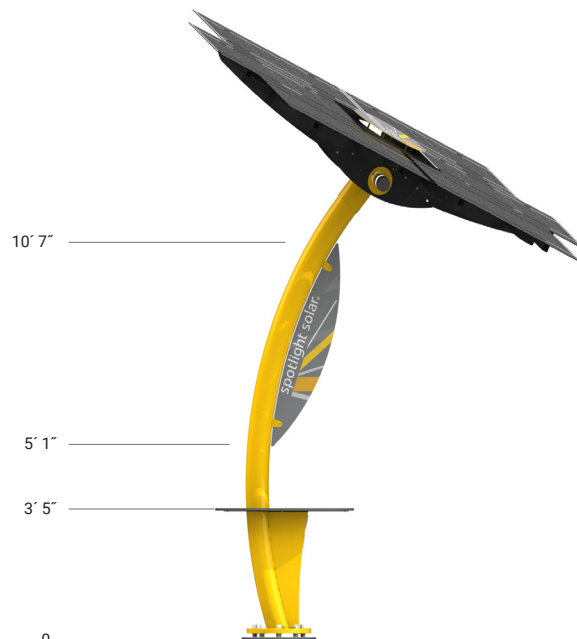

Shown with optional standing height table and sign on stem

Specifications	
Warranty	10 year limited warranty
Maximum height	18'
Total weight	1,040 lbs. (ships in pieces)
Wind load rating	175 MPH
Material	Recycled steel
Finish	High performance coating, client's color choice
Solar panel requirement	Lumos LSX frameless
Provided by Spotlight Solar: mounting structure, module attachment hardware, installation and orientation guidelines	
Provided by solar integrator: Solar modules, inverter, wiring, foundation, electrical design, installation, permitting, site-specific engineering	
Configuration	Product Number
1 Array (6 panels)	CRV-103061
Accessories	
LED accent lights	ACC-110001
Standing height table with power outlets	CRV-160000
Seating with power outlets	CRV-150000
Sign on stem	CRV-170000
Joint logo plate	ACC-170001
Top disk logo plate	CRV-170004

Updated 9.17.2019

Spotlight Solar is up to something good.



Spotlight Solar is dedicated to making solar energy visible and attractive. We don't replace rooftop systems; we complement them. Our ambition is to promote the adoption of solar energy by making it more visible and engaging.